



FriFri Precision 211 Electric Free-standing Single Tank Fryer - W 200mm









FriFri Precision for the chef who wants superb temperature control for consistently excellent results.



Precision is the fryer of choice.

- ✓ Electronic temperature control and powerful elements maintains oil to within +/- 1°C of the temperature selected, reducing oil usage and ensuring your food always has that all-important crunch.
 - ✓ With one cooking programme, perfect for when you want to cook the same product time after time, to the same exacting standards.
 - ✓ Digital timer displays the count down, with a buzzer sounding at the end of the cook cycle.
 - ✓ Temperature view shows current oil temperature, enabling you to make an informed decision as to when to start cooking.
 - ✓ Are there more fries than last time? Adaptive cooking automatically adjusts the cooking times to suit your batch size ensuring you never serve undercooked food.
 - ✓ Keeping your oil in peak condition! Optional xFri® filters the oil at the push of a button and returns oil to the tank. Filter the oil safely, even while it's still hot, mid service if necessary, and resume frying in minutes – so easy there is no excuse not to!
 - ✓ Extend oil life by up to 75% with the integral oil filtration system, saving you money on oil purchase and disposal costs.
 - ✓ Raising food to the next level. Perfect for kitchens where you don't have time for constant supervision, optional LiftFri® automatic basket lifting system lifts food at the end of the cycle to prevent overcooking.
 - ✓ Pressed tank for strength and durability. Radiused corners for easy cleaning. Hinged elements with two tilt positions for draining and cleaning.
- Fat melt cycle gently pulses to melt solid fats.

As standard

- 
 Electronic Temperature Control
- 
 Touchpad Control
- 
 Timer
- 
 Temperature View
- 
 Adaptive Cooking
- 
 Gravity-fed Oil Filtration
- 
 Vertically Coiled Elements

Optional

- 
 xFri® Pumped Oil Filtration Option
- 
 LiftFri® Automatic Basket Lift Option
- 
 SOLAS Specification Option

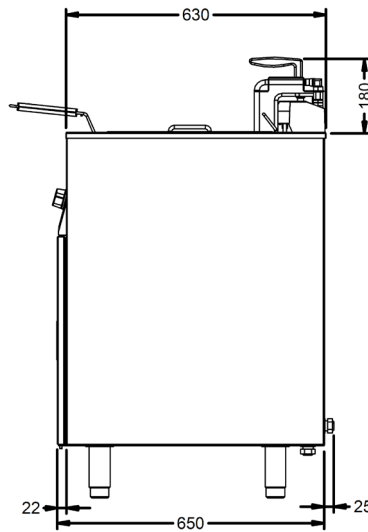
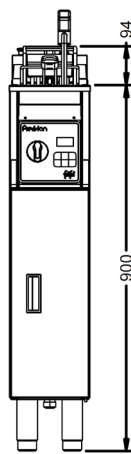
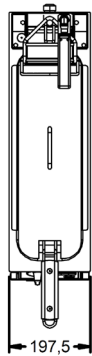

HxWxD
894x197.5x650



47



Electric supply

Fryer Designer

Please use our Fryer Designer to create your bespoke code.

Do you want an alternative configuration of baskets?

How many supply cables would you like?

Do you require chargeable add on items such as castors and pumped oil filtration?

Range	Base Mounting	Fryer Width	Number Of Tanks	Number Of Baskets	Element Power	Phase	Cables	Filtration / Pumps	Number of Basket Lifts
Precision	Legs SOLAS feet and buzzer for marine (free-standing only)	200mm	1	1	Low 7.5 kW Medium 9.0 kW High 11.0 kW	1 - 230V 1 NAC 3 - 400V 3 NAC 5 - 230V 1 AC 6 - 230V 3 AC 7 - 400V 3 AC 8 - 440V 3 AC	1	Gravity Filtration 1 Pump	0 1

If you would like help to create code please call us on 01522 875500.



Friteuse électrique FriFri Precision 211 sur coffre à cuve simple - L 200 mm



FriFri Precision pour les chefs qui veulent un excellent contrôle de la température pour des résultats de qualité réguliers.

Precision est la friteuse d'excellence.

- ✓ Le contrôle électronique de la température et de puissants éléments chauffants maintiennent l'huile à +/- 1°C de la température sélectionnée, ce qui réduit la consommation d'huile et garantit que vos aliments auront toujours ce croustillant important.
 - ✓ Avec un programme de cuisson, parfait pour cuisiner le même produit à chaque fois, et exactement selon les mêmes normes.
 - ✓ La minuterie numérique affiche le compte à rebours, avec une sonnerie à la fin du cycle de cuisson.
 - ✓ L'affichage de la température indique la température actuelle de l'huile, ce qui vous permet de décider en toute connaissance de cause à quel moment commencer la cuisson.
 - ✓ Il y a plus de frites que la dernière fois ? La cuisson adaptative ajuste automatiquement les temps de cuisson à la taille de votre lot et vous garantit de ne jamais servir des aliments insuffisamment cuits.
 - ✓ Gardez votre huile en condition optimale ! La xFri© en option filtre l'huile d'une simple pression sur un bouton et renvoie l'huile vers la cuve. Filtrez l'huile en toute sécurité, même lorsqu'elle est encore chaude, entre les cuissons si nécessaire, et reprenez la friture en quelques minutes - tellement facile qu'il n'y a aucune excuse pour ne pas le faire !
 - ✓ Prolongez la durée de vie de l'huile jusqu'à 75% avec le système de filtration d'huile intégré, en faisant des économies sur les coûts d'achat et d'élimination.
 - ✓ Faire passer l'alimentation au niveau supérieur. Parfaite pour les cuisines que vous n'avez pas le temps de surveiller en permanence, le système de levage automatique du panier en option LiftFri© soulève les aliments à la fin du cycle pour éviter qu'ils ne soient trop cuits.
 - ✓ Cuve pressée pour plus de robustesse et de durabilité. Coins arrondis pour un nettoyage facile. Éléments articulés avec deux positions d'inclinaison pour la vidange et le nettoyage.
- Le cycle de fonte des graisses émet de faibles impulsions pour faire fondre les graisses solides.

En standard



Commande électronique de température



Commande de pave tactile



Minuterie



Affichage de température



Cuisson adaptative



Filtration d'huile alimentée par gravité



Éléments spiralés verticalement

En option



Filtration xFri© d'huile pompée



Option de relevage automatique LiftFri© de



Option de spécifications SOLAS

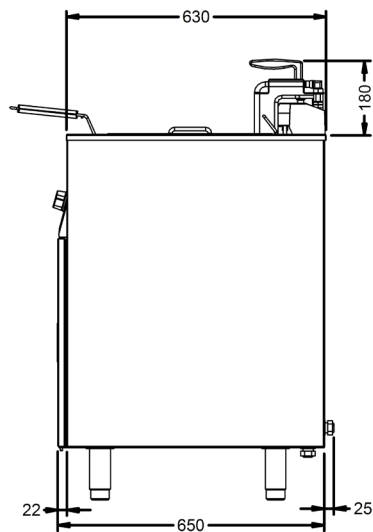
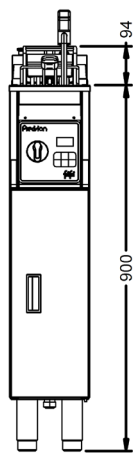
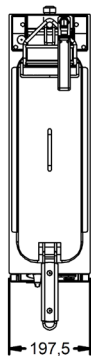

Concepteur de friteuses

Utilisez notre concepteur de friteuses pour créer votre code sur mesure.

Souhaitez-vous une autre configuration pour les paniers ?

Combien de câbles d'alimentation voulez-vous ?

Avez-vous besoin d'articles payants supplémentaires comme des roulettes et une filtration de l'huile pompée ?

Gamme	Socle de montage	Largeur de la friteuse	Nbre de cuves	Nbre de paniers	Puissance de l'élément	Phase	Câbles	Filtration / Pompes	Nbre de relevages
Precision	Pieds Pieds et sonnerie SOLAS pour les bateaux (sur coffre uniquement)	200 mm	1	1	Faible 7,5 kW Moyenne 9,0 kW Élevée 11,0 kW	1- 230V 1 NAC 3- 400V 3 NAC 5- 230V 1 AC 6 - 230V 3 AC 7 - 400V 3 AC 8 - 440V 3 AC	1	Filtr. par gravité 1 Pompe	0 1

Si vous avez besoin d'aide pour créer le code, appelez-nous au 01522 875500.

DE

FriFri Precision 211 Elektrische freistehende Fritteuse mit einem Becken – B 200 mm









Die FriFri Precision ist für Köche, die eine überragende Temperaturkontrolle für gleichbleibend exzellente Ergebnisse wünschen.

Precision ist die Fritteuse der Wahl.



- ✓ Die elektronische Temperaturregelung und die leistungsstarken Heizelemente sorgen dafür, dass das Öl nie mehr als +1 °C vom gewünschten Wert abweicht. So wird der Ölverbrauch reduziert und sichergestellt, dass Ihre Speisen immer unwiderstehlich knusprig sind.
- ✓ Das Kochprogramm ist ideal, wenn Sie ein und dasselbe Produkt immer wieder nach den gleichen hohen Standards zubereiten wollen.
- ✓ Die digitale Zeitschaltuhr zeigt einen Countdown an und am Ende des Frittiervorgangs ertönt ein Summer.
- ✓ Die Temperaturanzeige zeigt die aktuelle Öltemperatur an, sodass Sie eine fundierte Entscheidung treffen können, wann Sie mit dem Frittieren beginnen sollten.
- ✓ Sind es mehr Pommes frites als beim letzten Mal? Die Mengenautomatik passt die Zubereitungszeiten automatisch an die jeweilige Produktmenge an und verhindert, dass Sie unzureichend frittierte Speisen servieren.
- ✓ So bleibt Ihr Öl in Topform! Optionaler xFri®-Filter filtert das Öl auf Knopfdruck und führt Öl in das Becken zurück. Sie können das Öl auch heiß sicher filtern, falls nötig während der Verwendung, und in unter fünf Minuten wieder mit dem Frittieren beginnen!
- ✓ Verlängern Sie die Lebensdauer des Öls mit dem integrierten Ölfiltersystem um bis zu 75 % und sparen Sie Geld bei Ölkauf und Entsorgung.
- ✓ Für Lebensmittel auf einem neuen Level. Perfekt für Küchen, in denen Sie keine Zeit für eine ständige Überwachung haben: Das optionale automatische LiftFri®-Korbhebesystem hebt die Speisen am Ende des Zyklus an, um zu langes Frittieren zu verhindern.
- ✓ Gepresstes Becken für Festigkeit und Haltbarkeit. Abgerundete Ecken für eine einfache Reinigung. Klappbare Elemente mit zwei Kippstellungen zum Entleeren und Reinigen.

Der Fettschmelzyklus pulsiert sanft, um feste Fette zu schmelzen.

Standardmäßig

- 
Elektronische Temperaturregelung
- 
Regelung über Touchpad
- 
Zeitschaltuhr
- 
Temperaturanzeige
- 
Mengenautomatik
- 
Ölfiltration durch Schwerkraft
- 
Vertikal gewickelte Heizelemente

Optional

- 
xFri® Ölpumpfiltersystem
- 
LiftFri® Optionale automatische Korbhebung
- 
Optionale SOLAS-Spezifikation

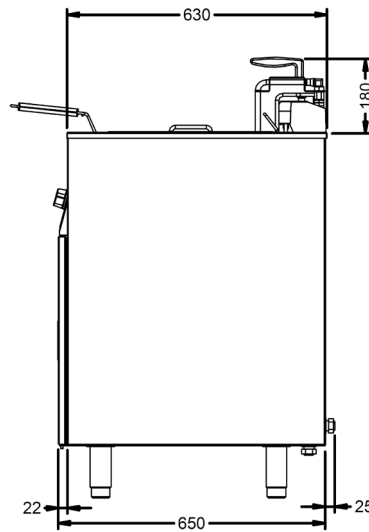
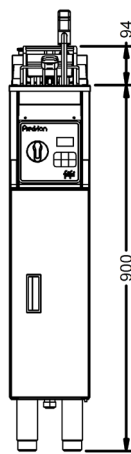
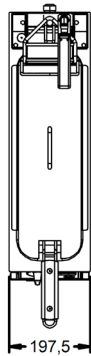

HxWxD
994x197.5x650



47



Elektroanschluss

Fritteusendesigner

Bitte verwenden Sie unseren Fritteusendesigner, um Ihren individuellen Code zu erstellen.

Möchten Sie eine andere Korbkonfiguration?

Wie viele Versorgungskabel brauchen Sie?

Brauchen Sie kostenpflichtige Zusatzausstattungen wie Rollen oder Ölpumpfiltersystem?

Produktlinie	Montage des Untergestells	Fritteusenbreite	Anzahl Becken	Anzahl Körbe	Leistung Heizelement	Phase	Kabel	Filtration/ Pumpen	Anzahl Korbhebungen
Precision	Beine SOLAS-Füße und Summer für Schiffe (nur freistehend)	200 mm	1	1	Niedrig 7,5 kW Mittel 9,0 kW Hoch 11,0 kW	1 - 230V 1 NAC 3 - 400V 3 NAC 5 - 230V 1 AC 6 - 230V 3 AC 7 - 400V 3 AC 8 - 440V 3 AC	1	Schwerkraftfiltr. 1 Pumpe	0 1

Wenn Sie Hilfe bei der Erstellung des Codes benötigen, rufen Sie uns bitte unter 01522 875500 an.



Friggitrice elettrica con mobile serbatoio
singolo FriFri Precision 211 - W 200mm



FriFri Precision: per gli chef che desiderano un ottimo controllo della temperatura per risultati eccellenti.

Precision è la friggitrice d'elezione.

- ✓ Il controllo elettronico della temperatura e le resistenze potenti mantengono l'olio entro +/- 1°C dalla temperatura selezionata, riducendone l'olio usato e garantendo al cibo quella croccantezza fondamentale.
- ✓ Grazie al programma di cottura singolo, è ideale per cucinare più volte lo stesso prodotto secondo gli stessi identici standard.
- ✓ Il timer digitale visualizza il count down, mentre il segnalatore acustico suonerà al termine del ciclo di cottura.
- ✓ La visualizzazione della temperatura mostra la temperatura attuale dell'olio, consentendo di prendere decisioni consapevoli sull'avvio della cottura.
- ✓ Ci sono più patatine dell'ultima volta? La cottura adattiva regola automaticamente i tempi di cottura in base alla quantità, in modo che il cibo servito non risulti mai poco cotto.

- ✓ Olio mantenuto in condizioni ottimali! Con la semplice pressione di un pulsante, il sistema xFri® optional filtra l'olio e lo riconvolgia nel serbatoio. In questo modo, l'olio viene filtrato in sicurezza, persino quando è ancora bollente (anche a metà servizio, se necessario) e la friggitrice si riattina in pochi minuti, per cui non ci sono scuse!
- ✓ La durata dell'olio risulta prolungata fino al 75% grazie al sistema integrato di filtraggio dell'olio e consente di risparmiare sull'acquisto dell'olio e sui costi di smaltimento.
- ✓ Il passaggio del cibo al livello successivo. Ideale per le cucine in cui non c'è tempo per una supervisione costante, il sistema di sollevamento automatico del cestello LiftFri® solleva il cibo alla fine del ciclo per evitare la cottura eccessiva.
- ✓ Serbatoio compresso per ottimizzare resistenza e durata. Spigoli a raggiera per facilitare la pulizia. Elementi incernierati con due posizioni di inclinazione per scarico e pulizia.

Il ciclo di scioglimento grassi pulsa delicatamente per sciogliere i grassi solidi.

Standard



Controllo elettronico della temperatura



Controllo mediante touchpad



Timer



Visualizzazione temperatura



Cottura adattiva



Filtraggio dell'olio per gravità



Resistenze a bobina verticale

Optional



Filtraggio dell'olio tramite pompa xFri®



Opzione di sollevamento automatico del cestello LiftFri®



Opzione specifiche SOLAS

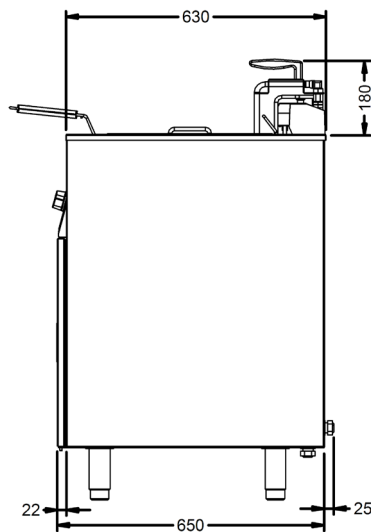
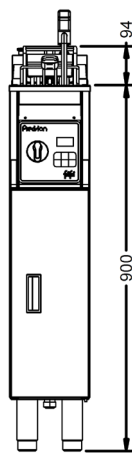
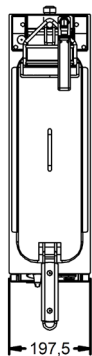

HxWxD
994x197.5x650



47



Alimentazione elettrica

Designer delle friggitrici

Utilizzate il Designer delle friggitrici per creare il vostro codice su misura.

Siete interessati a una configurazione alternativa dei cestelli?

Quanti cavi di alimentazione sono necessari?

Siete interessati ad articoli aggiuntivi a pagamento come rotelle o filtraggio dell'olio a pompa?

Gamma	Montaggio base	Larghezza friggitrice	Numero di serbatoi	Numero di cestelli	Potenza Potenza	Fase	Cavi	Filtraggio/ Pompe	Numero di sollevamenti cestello
Precision	Piedini SOLAS: piedini e segnalatore acustico per uso marittimo (solo con mobile)	200mm	1	1	Basso 7.5 kW Medio 9.0 kW Alto 11.0 kW	1 - 230V 1 NAC 3 - 400v 3 NAC 5 - 230V 1 AC 6 - 230V 3 AC 7 - 400V 3 AC 8 - 440V 3 AC	1	Filtr. per gravità 1 Pompa	0 1

Per farlo, potete contattarci al numero 01522 875500.

ESP

Freidora eléctrica independiente con un depósito 211 Precision Frifri - 200 mm de ancho



La gama Precision de Frifri es ideal para quienes desean un excelente control de la temperatura para obtener siempre resultados excelentes.

¡Las freidoras Frifri siempre son una buena elección!

- ✓ El control electrónico de la temperatura y los potentes elementos mantienen el aceite dentro de un margen de +/- 1 °C de la temperatura fijada, reduciendo la absorción de aceite y asegurando que su comida siempre tenga ese crujido tan importante.
- ✓ Su programa de cocinado único permite cocinar el mismo producto una y otra vez, con los mismos estándares de exigencia.
- ✓ Gracias a su temporizador digital, podrá ver la cuenta atrás en la pantalla. Además, un indicador acústico le avisará al final del ciclo de cocción.
- ✓ El visor de temperatura le muestra la temperatura actual del aceite, lo que le permite tomar una decisión informada sobre cuándo empezar a cocinar.
- ✓ ¿Hay más patatas fritas que la última vez? La cocción adaptativa ajusta automáticamente los tiempos de cocción para adaptarse al tamaño del lote, lo que garantiza que nunca se sirva comida poco hecha.
- ✓ ¡Mantenga el aceite en las condiciones óptimas! Con solo pulsar un botón, el sistema opcional xFri® filtra el aceite usado y devuelve el aceite limpio al depósito. Esto le permite filtrar el aceite de forma segura, incluso mientras está caliente o a mitad de servicio si es necesario, y volver a freír en minutos. ¡Es tan fácil que no hay excusa para no hacerlo!
- ✓ Gracias al sistema integral de filtrado de aceite, puede prolongar la vida útil del aceite hasta un 75 %, lo que le permite ahorrar dinero tanto en la compra de aceite como en los costes de eliminación.
- ✓ ¡Comida al máximo nivel! El sistema de elevación automática de cestas LiftFri®, ideal para cocinas en las que no se supervisa constantemente el tiempo, eleva los alimentos al final del ciclo para evitar que se cocinen en exceso.
- ✓ Depósito prensado para mayor resistencia y durabilidad. Esquinas redondeadas para facilitar la limpieza. Elementos abatibles con dos posiciones de inclinación para el correcto drenaje y limpieza.

El ciclo de fusión de grasas funde suavemente las grasas sólidas.

De serie

-  Control electrónico de la temperatura
-  Control del panel táctil
-  Temporizador
-  Visor de temperatura
-  Cocción adaptativa
-  Filtración de aceite por gravedad
-  Elementos enrollados verticalmente

Opcional

-  Filtración de aceite por bombeo xFri®
-  Opción de elevación automática de cestas LiftFri®
-  Especific SOLAS | barcos

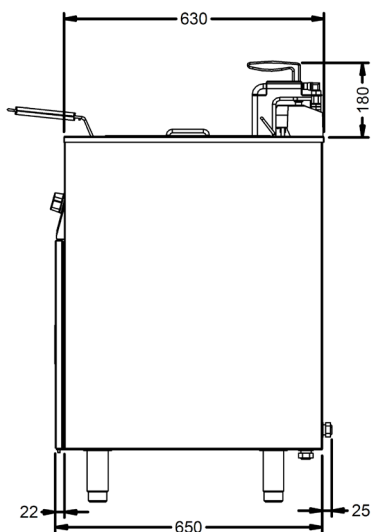
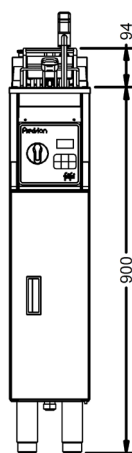
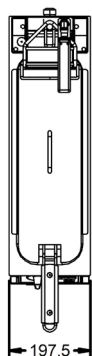

HxWxD
994 x 197,5 x
650



47



Suministro eléctrico

Diseñador de freidoras

Utilice nuestro diseñador de freidoras para crear su modelo a medida.

¿Quiere una configuración alternativa de las cestas?

¿Cuántos cables de alimentación quiere?

¿Necesita elementos adicionales de pago, como ruedas y filtración de aceite por bombeo?

Rango	Montaje de la base	Ancho de la freidora	Número de depósitos	Número de cestas	Potencia del elemento	Fase	Cables	Filtración / Bombas	Número de elevaciones de cestas
Precision	Patatas Patatas e Indicador acústico con especificación SOLAS para barcos (solo en modelos independientes)	200 mm	1	1	Baja 7,5 kW Media 9,0 kW Alta 11,0 kW	1 - 230 V 1 CD 3 - 400 V 3 CD 5 - 230 V 1 CA 6 - 230 V 3 CA 7 - 400 V 3 CA 8 - 440 V 3 CA	1	Filtr. por gravedad 1 bomba	0 1

Si quiere que le asesoremos, llámenos al 01522 875500.